

EMI/RFI Shielded Ventilation Panels (3000 Series)

MAJR's line of ready-to-install honeycomb cooling vents provide optimum EMI/RFI shielding with minimum pressure drop for the ventilating air. Shielding effectiveness is accomplished using waveguide design principles.

The choice of the shielded honeycomb that best meets design considerations is based on three main criteria: Shielding, Air Flow and Mounting. For most applications aluminum Code-32 honeycomb (properly installed using MAJR's mounting frame with integral EMI/RFI gasket) will provide a degree of attenuation that will be within specification limits (See Table 1). However, for the lower frequency range (H-Field) it may be necessary to specify MAJR's material Tin Plated Steel Code-44. Although heavier in weight than aluminum, an increase of 20-40dB H-field shielding effectiveness can be achieved in the lower frequency range by the use of the higher permeable-44 grade.

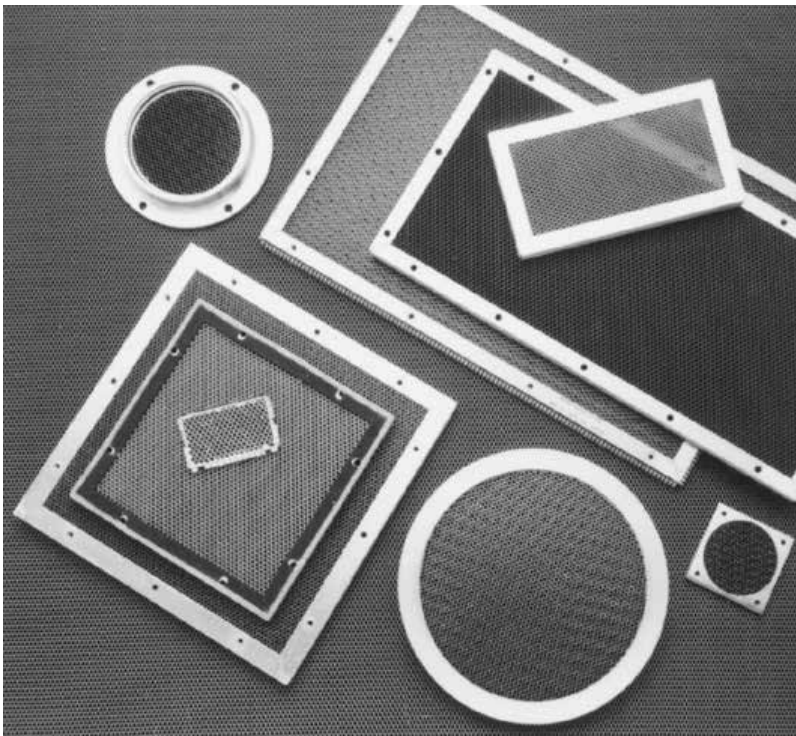

Radiated emission testing of 12 in. x 12 in. x 0.5 in honeycomb vent panels:

Aluminum, chromate coated, (E Field and Plane Wave, 40 dB to 18 GHz)

Aluminum, tin plated, (E Field and Plane Wave, 60 dB to 18 GHz)

Steel, tin plated, (E Field and Plane Wave, 80 dB to 18 GHz) and (Magnetic H-Field, 40 dB to 1 MHz)

Features

- **Ease of Installation**
Shielded air vents are supplied with EMI gasket and mounting holes or captive fasteners so as to be ready for installation into the cabinet.
- **Special Designs**
MAJR's engineering group can assist with applications requiring special mounting or shape.
- **Painted Units**
Vents mounted on the outside of cabinet can be supplied with exposed surfaces painted to meet the Military Standard color of the cabinet.
- **Optimum Shielding and Air Flow**
Installation of the honeycomb — with its 4:1 opening to depth ratio — provides the waveguide below cut-off effect required to attenuate EMI/RFI interference while not impeding the air flow required to cool the packaged enclosure.
- **Standard Configurations**
A broad selection of sizes provides the widest choice in meeting design objectives.
- **RoHS compliant available**

Air Flow Resistance — Figure 1

The low resistance to air flow of MAJR'S shielded honeycomb panels will minimize pressure drop within cabinet, allowing air to move freely through the intake and exhaust to perform the desired cooling function. The curves in Figure 1 show the resistance per square inch for standard honeycomb vents.

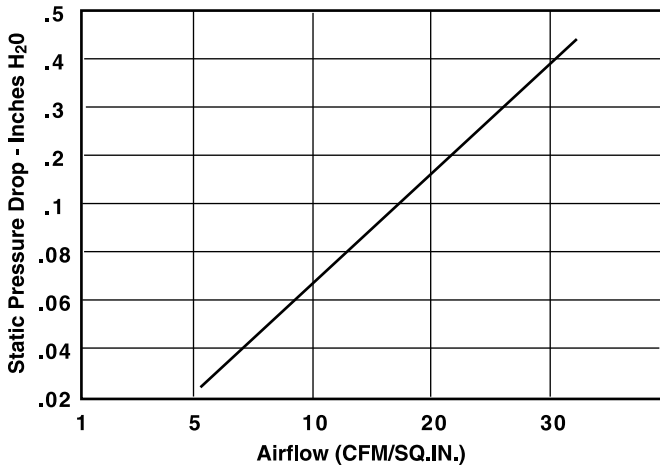
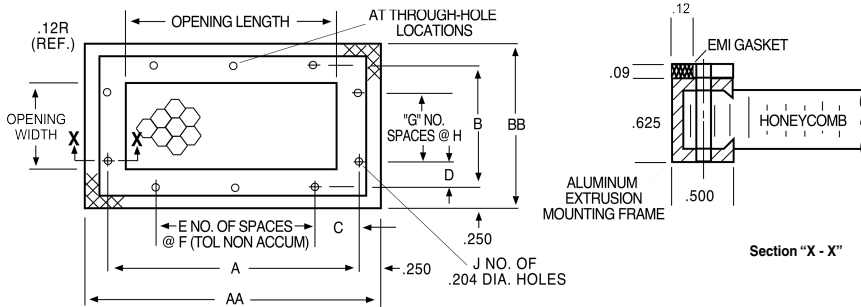

Figure 7 - Style 3031
EMI/RFI Shielded Ventilation Panel with Through Holes



Mounting Installation

Four mounting frames are offered as a standard for installation into the cabinet. In each case, the extruded aluminum frame is designed with a "tooth" that bites into the filter grill to ensure grounding of frame to filter media.

Figure 2

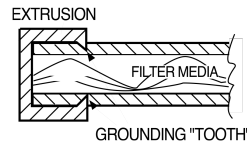

Figure 3
Through Hole Style 3031

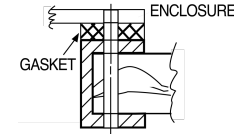

Figure 4
Captive Fastener Style 3032

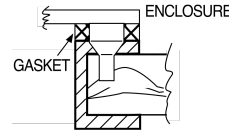

Figure 5
Recess Mount Style 3036

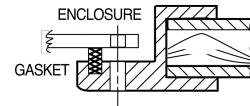
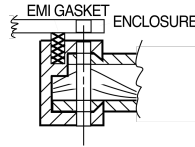

Figure 6
Through Hole Style 3033



OPENING		Part Number -32 Material	FRAME DIMENSIONS										
Width	Length		AA	BB	A	B	C	D	E	F	G	H	J
3.00 (76.2)	3.00 (76.2)	3031-20303-xx	4.00 (101.6)	4.00 (101.6)	3.50 (88.9)	3.50 (88.9)	1.75 (44.5)	1.75 (44.5)	—	—	—	—	4
3.00 (76.2)	5.00 (127.0)	3031-20305-xx	6.00 (152.4)	4.00 (101.6)	5.50 (139.7)	3.50 (88.9)	1.00 (25.4)	1.75 (44.5)	1	3.50 (88.9)	—	—	6
3.00 (76.2)	11.00 (279.4)	3031-20311-xx	12.00 (304.8)	4.00 (101.6)	11.50 (292.1)	3.50 (88.9)	1.25 (31.8)	1.75 (44.5)	3	3.00 (76.2)	—	—	10
4.00 (101.6)	4.00 (101.6)	3031-20404-xx	5.00 (127.0)	5.00 (127.0)	4.50 (114.3)	4.50 (114.3)	.750 (19.1)	2.25 (57.2)	1	3.00 (76.2)	—	—	6
4.00 (101.6)	9.00 (228.6)	3031-20409-xx	10.00 (254.0)	5.00 (127.0)	9.50 (241.3)	4.50 (114.3)	1.25 (31.8)	2.25 (57.2)	2	3.50 (88.9)	—	—	8
5.00 (127.0)	5.00 (127.0)	3031-20505-xx	6.00 (152.4)	6.00 (152.4)	5.50 (139.7)	5.50 (139.7)	1.00 (25.4)	1.00 (25.4)	1	3.50 (88.9)	1	3.50 (88.9)	8
5.00 (127.0)	11.00 (279.4)	3031-20511-xx	12.00 (304.8)	6.00 (152.4)	11.50 (292.1)	5.50 (139.7)	1.25 (31.8)	1.00 (25.4)	3	3.00 (76.2)	1	3.50 (88.9)	12
6.00 (152.4)	6.00 (152.4)	3031-20606-xx	7.00 (177.8)	7.00 (177.8)	6.50 (165.1)	6.50 (165.1)	1.50 (38.1)	1.50 (38.1)	1	3.50 (88.9)	1	3.50 (88.9)	8
6.00 (152.4)	9.00 (228.6)	3031-20609-xx	10.00 (254.0)	7.00 (177.8)	9.50 (241.3)	6.50 (165.1)	1.25 (31.8)	1.50 (38.1)	2	3.50 (88.9)	1	3.50 (88.9)	10
7.00 (177.8)	14.00 (355.6)	3031-20714-xx	15.00 (381.0)	8.00 (203.2)	14.50 (368.3)	7.50 (190.5)	.750 (19.1)	.750 (19.1)	4	3.25 (82.6)	2	3.00 (76.2)	16
9.00 (228.6)	9.00 (228.6)	3031-20909-xx	10.00 (254.0)	10.00 (254.0)	9.50 (241.3)	9.50 (241.3)	1.25 (31.8)	1.25 (31.8)	2	3.50 (88.9)	2	3.50 (88.9)	12
11.00 (279.4)	11.00 (279.4)	3031-21111-xx	12.00 (304.8)	12.00 (304.8)	11.50 (292.1)	11.50 (292.1)	1.25 (31.8)	1.25 (31.8)	3	3.00 (76.2)	3	3.00 (76.2)	16
14.00 (355.6)	14.00 (355.6)	3031-21414-xx	15.00 (381.0)	15.00 (381.0)	14.50 (368.3)	14.50 (368.3)	1.25 (31.8)	1.25 (31.8)	4	3.00 (76.2)	4	3.00 (76.2)	20
18.00 (457.2)	18.00 (457.2)	3031-21818-xx	19.00 (482.6)	19.00 (482.6)	18.50 (469.9)	18.50 (469.9)	1.75 (44.5)	1.75 (44.5)	5	3.00 (76.2)	5	3.00 (76.2)	24

-xx = Required Finish : -32 (chromate aluminum), -42 (tin aluminum), -44 (tin steel), -90 (RoHS compliant)